

# VLF Hipot Tester



## Introduction

I. Thank you for using our products, so you have our comprehensive technical support and service.

this product manual is applicable to series of ultra-low frequency and high voltage generators.

before using this product, please read the instruction manual carefully and keep it for reference.

this product is a test instrument for high-voltage electrical equipment. Please operate according to the operation instructions and strictly abide by the relevant national regulations. Improper use may endanger equipment and personal safety.

if you have any doubts in the process of reading the operation manual or using the instrument, you can consult our company.

## Matters Needing Attention



**1. Please strictly follow the safety regulations for high-voltage testing during the experiment and have professional personnel operate it;**



**2. If there is a malfunction in the instrument, do not disassemble and repair it yourself. Please contact our company immediately;**



**3. After shutting down, use a discharge rod to fully discharge the sample. After confirming that the discharge is complete, disconnect the wire!**



**4. Strictly conduct tests when the cable capacity is unclear, and cables with a capacitance less than 0.05  $\mu$  F must be used in parallel with red capacitors.**



**5. During the withstand voltage test, maintain a safe distance of at least 1m. It is prohibited to suddenly cut off power or discharge the casing with high voltage. Any damage to the booster caused by discharge is not responsible.**



**6. It is prohibited to use a booster without the test object or compensation capacitor, as damage to the booster is not related to the quality of the instrument itself and must be borne by the individual**



**7. No capacitor compensator is required for cables above 500m**



**8. Continuous breakdown test for 30 minutes to 1 hour, then cool down for 1 hour before testing. The booster needs to cool down before boosting again**



**9. Please note : Our brand VLF hipot tester is only allowed to be powered by your local power Grid Or variable frequency generators.**

## Contents

I. Overview .....	1
II. Advantages Of 0.1Hz Ultra-low Frequency Withstand Voltage Technology .....	1
III. Technical Parameters Of Series Products .....	3
IV. Product Features .....	5
V. Instrument Structure And Function Description .....	5
VII. Power Cable Withstand Voltage Test Method .....	15
VIII. Transportation And Preservation .....	16
IX. Quality Assurance .....	16
X. Paper Change Method Of Printer .....	17
XI. Common Faults .....	18
XII. Packing List .....	18

## I. Overview

High voltage withstand test of electrical equipment is one of the most important items specified in insulation preventive test.

The withstand voltage test can be divided into ac withstand voltage test and dc withstand voltage test. The ac withstand voltage test can be divided into power frequency, frequency conversion and 0.1hz ultra-low frequency test technology, of which 0.1hz ultra-low frequency technology is the latest technology recommended by the current international electrotechnical commission. Our company's new generation of ultra-low frequency and high voltage generator is the core product independently developed with the latest American technology. It adopts 7-inch touch screen, the latest arm7 single chip microcomputer, high-speed ad acquisition circuit, and is equipped with background management software. It overcomes many shortcomings of domestic similar products (see table 1), and its cost performance is much higher than that of similar imported products. It is especially suitable for withstand voltage test of electrical equipment with large insulation equivalent capacitance (such as power cable, power capacitor, large and medium-sized generator and motor, etc.), which conforms to the national standard of electric power industry, general technical conditions for ultra-low frequency and high voltage generator (d) newly issued in 2004 I / t849.4-2004.

0.1Hz voltage-withstand equipment type	HV control method	High voltage waveform	Energy saving	Noise	Lifespan	Electrical life
mechanical	HV mechanical switch switching polarity	Square wave	Not energy-saving: consume excess energy with high-power resistors	High	short	Short
Electronic	HV electronic switch switching polarity	Sine wave	Energy saving: feed back excess power to the grid	A little	No lifespan, can use long-term	Long

Table 1 performance comparison between mechanical type and electronic type of 0.1Hz voltage withstand test equipment

## II. Advantages Of 0.1Hz Ultra-Low Frequency Withstand Voltage Technology

In fact, the ultra-low frequency insulation withstand voltage test is an alternative to the power frequency withstand voltage test. In the power frequency withstand voltage test of large and medium-sized generators, motors, power cables and other test objects, due to their large capacitance in the insulation layer, a large capacity test transformer or resonance transformer is

required. Some of these huge equipment is not only heavy and expensive, but also inconvenient to use. In order to solve this contradiction, the method of reducing the test frequency and the capacity of the test power supply is widely used in the world. It has been proved from many years of theory and practice at home and abroad that replacing power frequency withstand voltage test with 0.1Hz ultra-low frequency withstand voltage test can not only have the same equivalence, but also greatly reduce the volume and weight of the equipment, theoretically, the capacity is about one fifth of the power frequency, and the operation is simple. This is the main reason why this method is widely used in developed countries.

According to the actual situation of China's power system, the national development and Reform Commission has formulated the industry standard of ultra-low frequency (0.1Hz) withstand voltage test method for 35kV and below XLPE insulated power cables. In 2004, the industry standard DL / T 849.4-2004, general technical conditions for ultra-low frequency and high voltage generators, which is being promoted in China. Although the DC voltage withstand test equipment has the advantages of small size, light weight and low cost, the DC voltage withstand test is also the most destructive to the insulation of the tested object. (see Table 2) therefore, the latest national regulations on preventive test of electrical equipment have expressly stipulated that DC high voltage is no longer used for voltage withstand test of electrical equipment, and AC voltage withstand test is recommended.

The new generation of 0.1Hz ultra-low frequency high voltage generator developed by our company adopts the latest power electronic components and the latest ARM7 single-chip technology, further reducing the volume and weight of the equipment, fool operation, more stable performance, overcoming the shortcomings of the first generation of mechanical booster, such as short service life, high failure rate and large volume. Through years of practice, a large number of user feedback shows that: - 80kV ultra-low frequency high voltage technology is leading in the country, with the highest cost performance!

Table 2 performance comparison of various withstand voltage test equipment:

Compare content	Power frequency withstand voltage	Frequency withstand voltage	0.1Hz withstand voltage	DC withstand voltage
Equivalence	good	Good	Good	Bad
Insulation destructive	small	small	small	big
Operation safety	low	low	high	A little low
Wiring	Complicated	Most Complicated	Most easy	complicated
Volume and weight	Heavy and big	Heavy and big	Light and small size	Light and small size

### III. Technical Parameters Of Series Products

1. Output rated voltage: See table 3
2. Output frequency: 0.1Hz、0.05Hz、0.02Hz、0.01Hz
3. Carrying capacity: 0.1Hz max 0.5 $\mu$ F  
                                   0.05Hz max 1.1 $\mu$ F  
                                   0.02Hz max 2.2 $\mu$ F  
                                   0.01Hz max 5.5 $\mu$ F
4. Measurement accuracy: 3%
5. Voltage positive, negative peak error:  $\leq 3\%$
6. Voltage waveform distortion degree:  $\leq 5\%$
7. Conditions of use: indoor, outdoor; temperature:  $-10^{\circ}\text{C}\sim+40^{\circ}\text{C}$ ; humidity:  $\leq 85\%$ RH
8. Power supply fuse: See table 3
9. Power Supply: Voltage 220V $\pm 5\%$ , 60Hz

Note: If the portable generator is used for power supply, the generator output voltage and frequency are required to be stable (generally, the power is greater than 3kW, the frequency is 60Hz, and the voltage is 220V $\pm 5\%$ )

10. The electrical capacity of the subject shall not exceed the maximum rated electrical capacity of the instrument, and the value is shown in the table 3;

Model	Rated voltage	Carrying capacity	Power source Safety tube	Product structure and weight
30/1.1	30kV (Peak value)	0.1Hz, $\leq 1.1\mu\text{F}$	10A	Controller: 4kg Voltage booster: 20kg
		0.05Hz, $\leq 2.2\mu\text{F}$		
		0.02Hz, $\leq 4.4\mu\text{F}$		
		0.01Hz, $\leq 10\mu\text{F}$		
40/1.1	40kV (Peak value)	0.1Hz, $\leq 1.1\mu\text{F}$	10A	Controller: 4kg Voltage booster: 20kg
		0.05Hz, $\leq 2.2\mu\text{F}$		
		0.02Hz, $\leq 4.4\mu\text{F}$		
		0.01Hz, $\leq 10\mu\text{F}$		
50/1.1	50kV (Peak value)	0.1Hz, $\leq 1.1\mu\text{F}$	15A	Controller: 4kg Voltage booster: 40kg
		0.05Hz, $\leq 2.2\mu\text{F}$		
		0.02Hz, $\leq 4.4\mu\text{F}$		
		0.01Hz, $\leq 10\mu\text{F}$		
60/1.1	60kV (Peak value)	0.1Hz, $\leq 0.5\mu\text{F}$	15A	Controller: 4kg Voltage booster: 50kg
		0.05Hz, $\leq 1.1\mu\text{F}$		
		0.02Hz, $\leq 2.2\mu\text{F}$		

		0.01Hz, ≤5.5μF		
80/1.1	80kV (Peak value)	0.1Hz, ≤0.5μF	15A	Controller: 4kg Voltage booster: 50kg
		0.05Hz, ≤1.1μF		
		0.02Hz, ≤2.2μF		
		0.01Hz, ≤5.5μF		
90/1.1	90kV (Peak value)	0.1Hz, ≤0.5μF	15A	Controller: 4kg Voltage booster: 55kg
		0.05Hz, ≤1.1μF		
		0.02Hz, ≤2.2μF		
		0.01Hz, ≤5.5μF		

1) Select products of appropriate specifications according to the subjects

When in use, the capacitance of the test object shall not exceed the rated capacitance of the instrument. If the capacitance of the test object is too small, the output waveform will be affected. If it is less than 0.05 μ F, the instrument will not output normally. At this time, 0.05 μ f capacitor (provided by the company) can be connected in parallel for auxiliary output. See Table 4 and table 5 for the estimation of capacitance of common electrical equipment.

Table 4 single phase earth capacity of different types of generators.

Capacity (MW)	Steam turbine generator			Hydro generator			
	200	300	600	85	125-150	300	400
Single phase ground capacitance(μF)	0.198	0.18-0.26	0.31-0.34	0.69	1.8-1.9	1.7-2.5	2.0-2.5

Table 5 capacitance of XLPE insulated single core power cable (μ f / km)

capacitance (uf/Km) Voltage(KV)	Cross-sectional area (mm)										
	16	25	35	50	70	95	120	150	185	240	
10	0.15	0.17	0.18	0.19	0.21	0.24	0.26	0.28	0.32	0.38	
35	—	—	—	0.11	0.12	0.13	0.14	0.15	0.16	0.17	

2) Estimation method of test object current:

Calculation formula:  $I = 2 \pi FCU$

#### IV. Product Features

- ✧ Advanced technology: digital frequency conversion technology, microcomputer control, pressure rise, pressure reduction, measurement, protection, etc
- ✧ The test process is fully automated.
- ✧ Easy to operate: simple wiring, fool operation.
- ✧ Comprehensive protection: multiple protection (over-voltage protection, over-current protection at high and low voltage sides), rapid action (when acting Room  $\leq 10ms$ ), the instrument is safe and reliable.
- ✧ Safety and reliability: the controller is connected with the low voltage of the high voltage generator, with photoelectric control, safe and reliable use.
- ✧ The high and low voltage closed-loop negative feedback control circuit is adopted, and the output has no capacity rise effect.
- ✧ Complete configuration: capacitive touch screen, LCD Chinese character display, automatic storage, automatic printing.
- ✧ Large test range: 0.1Hz, 0.05Hz and 0.02hz multi frequency selection, large test range.
- ✧ Small volume and light weight: it is very convenient for outdoor operation.
- ✧ Upper computer background management software (selective assembly)

#### V. Instrument Structure And Function Description

The instrument consists of two parts: controller and booster. The structure and function of the two parts are as follows:

1. The layout of each part of the controller panel is shown in Figure 1, and the function description of each part is as follows:



Figure 1 Schematic diagram of controller panel

“” — Grounding terminal: it is connected with the earth when in use.

"Switch" - power switch: built-in indicator light, on when on, off when "AC220V" - power input socket, built-in fuse.

"Printer" - print test reports.

"Capacitive touch screen" - display test data and output waveform, and can be operated directly on the screen by hand.

"USB" - its function is used to communicate with the upper computer. "Stop" - for emergency stop test.

2. Structure diagram of booster

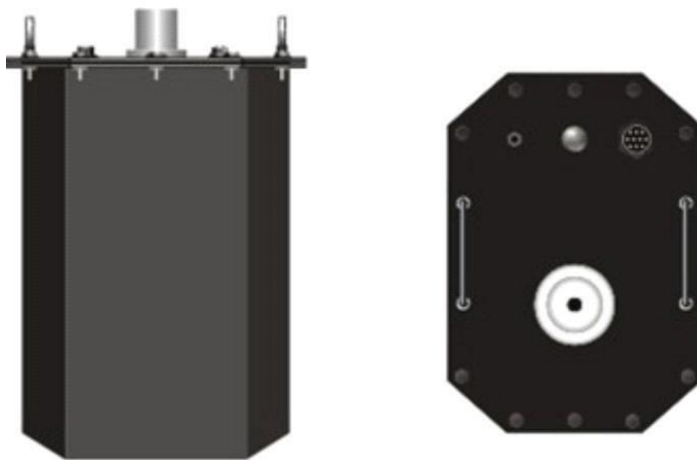

Figure 2 Schematic diagram of booster structure

**VI. Operation Instructions**

1. Ultra low frequency output wiring method

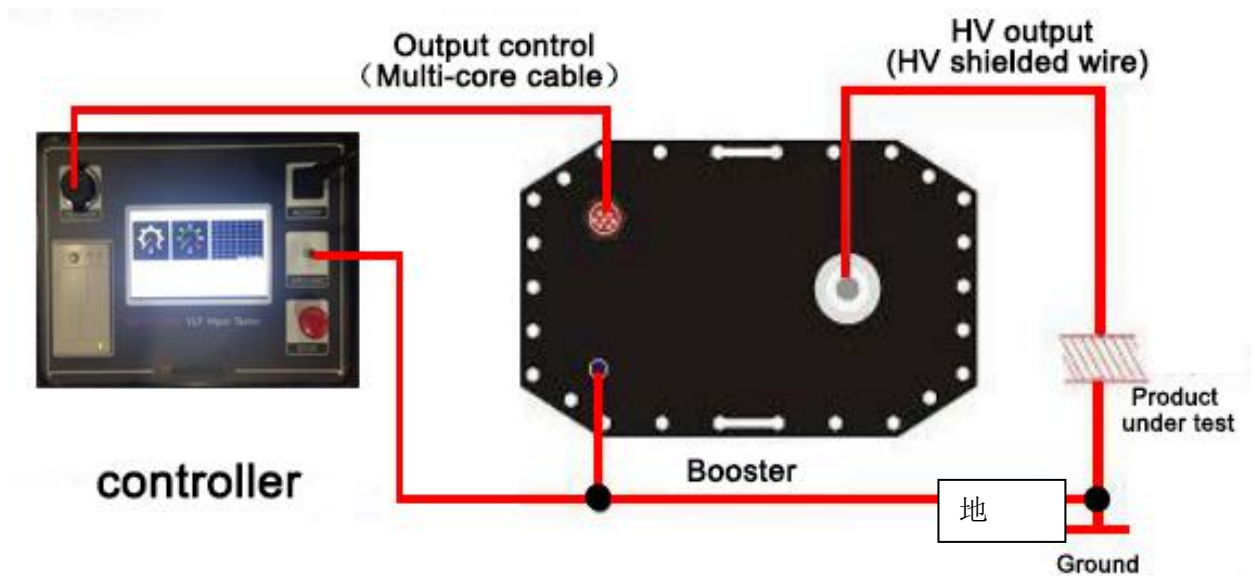

Figure 3 wiring diagram

Wiring instructions: connect the control output special line, high voltage output special line and grounding wire equipped with the product according to the method shown in Figure 3. The power cord of the power socket is connected to the AC of 220V / 60Hz.

**2. Operation procedure**

(1) startup, shutdown and reset

After connecting all the lines according to the above method, the power switch can be turned on. After the microcomputer is powered on or reset, the instrument will automatically enter the interface as shown in Figure 4. When connecting wires, removing wires, or temporarily not using the instrument, turn off the power supply. The power socket is equipped with a safety tube. If there is no display on the start-up screen, check whether the fuse is broken first, and the size of the fuse shall be replaced according to the data provided in Table 3.

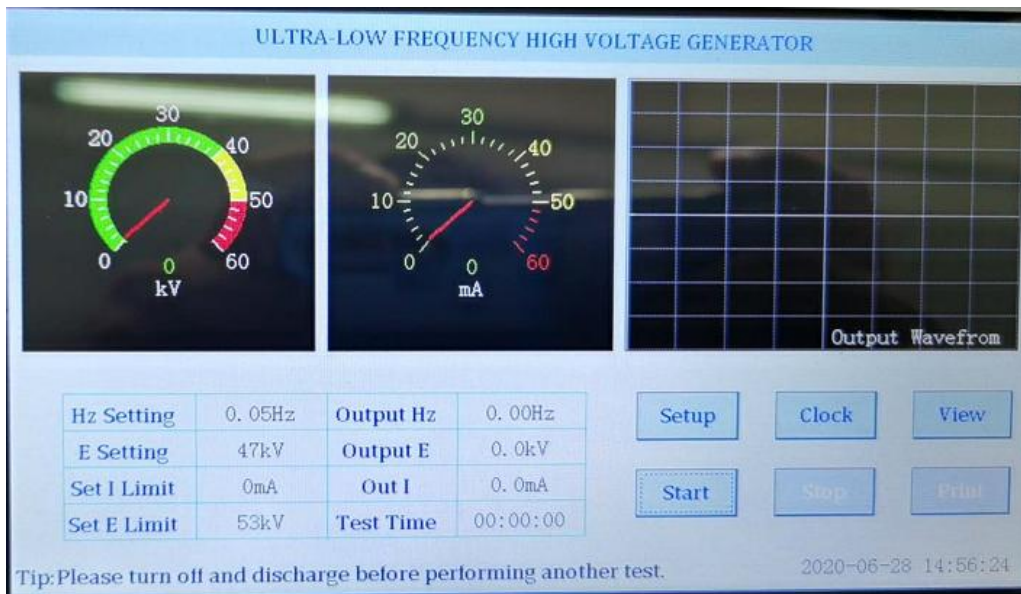

Figure 4 Schematic diagram of touch screen

(2) Set parameters

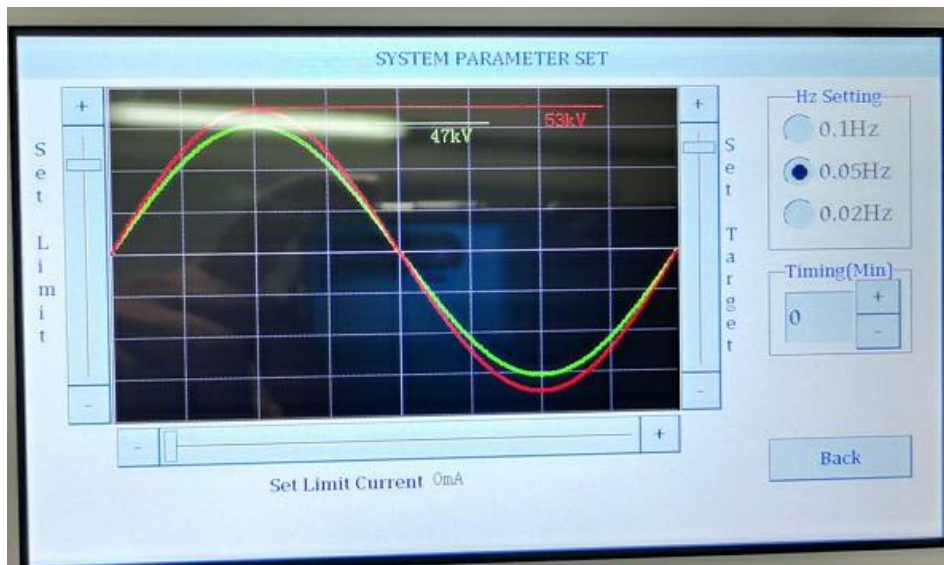

Figure 5 parameter setting interface

First, click the "setting" button on the screen of Figure 4 to display the setting parameter interface shown in Figure 5. In Figure 5, the output frequency, test time, test voltage, overcurrent protection value and overvoltage protection value on the high voltage side can be set according to the needs of the test. The modification method is as follows:

- ★ There are three options for frequency: 0.1, 0.05 and 0.02, and the unit is Hz.
  - ★ Timing modification range: 0-99 points. It specifies the duration of the test, in minutes.
  - ★ Set voltage: range from 0 to rated value, unit: kv. It sets the test voltage we want to raise. When the instrument rises to this set voltage limit, it will no longer boost voltage, and maintain constant amplitude sine wave output at this peak value.
  - ★ Set voltage limit: the setting range of voltage protection value is from 0 to rated value, and the unit is kv. It specifies the upper limit value of the voltage passing the test object. When the voltage exceeds this setting, the instrument will automatically cut off the output.
  - ★ Setting current limit: the setting range of current protection value is from 0 to rated value, and the unit is ma. It specifies the upper limit value of current passing through the test object. When the current exceeds this setting, the instrument will automatically cut off the output.
- (Note: the above voltage, current and measurement data displayed by the instrument are all peak values.)

(3) automatic boosting

After pressing the "start" key in Figure 4, the instrument will carry out the boosting test under

the control of the computer as follows:

Self-inspection →boosting →constant amplitude output →shutdown The specific process is as follows:

1) Self inspection process

The controller automatically enters the load detection. If no load is detected, the prompt message "load not connected" in the status bar of Figure 6 indicates that the booster or capacitive test sample is not connected.

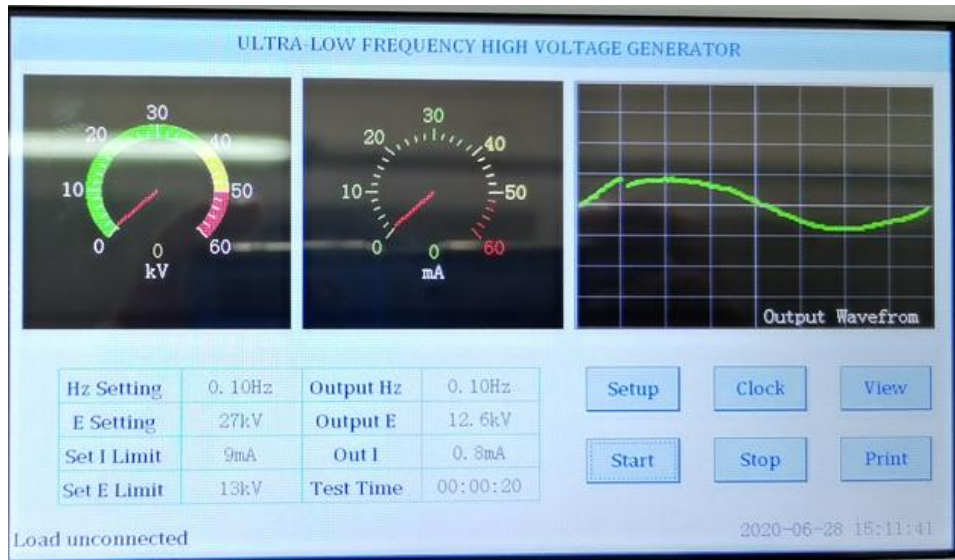

Figure 6 the controller indicates that the load is not connected

2) Boosting process

After the self-test is successful, the instrument will automatically enter the boosting state, as shown in Figure 7, and the prompt message in the status bar is "boosting". At the same time, the timing began.

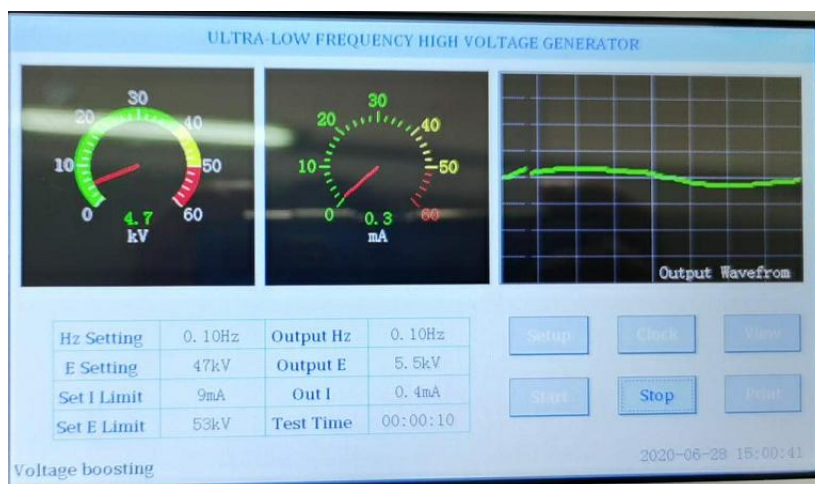
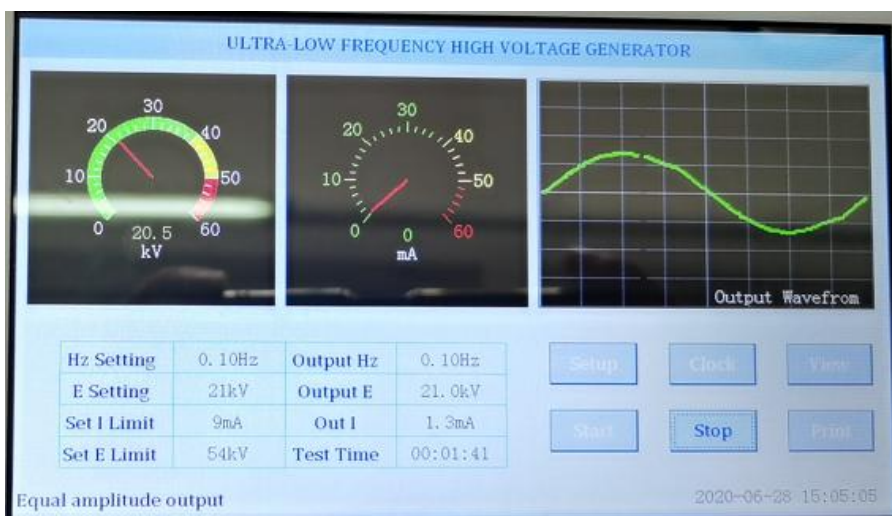

Figure 7 the controller indicates that the voltage is boosting



### 3) Equal amplitude output

The controller will raise the voltage to the set value in several cycles, and the instrument will output the equal amplitude, as shown in Figure 8. The prompt message in the status bar is "equal amplitude output".

Figure 8 constant amplitude output of controller prompt

### 4) Downtime

When the timing reaches the set time, the instrument will stop automatically, as shown in Figure 9, and the prompt message in the status bar is "stop the test".

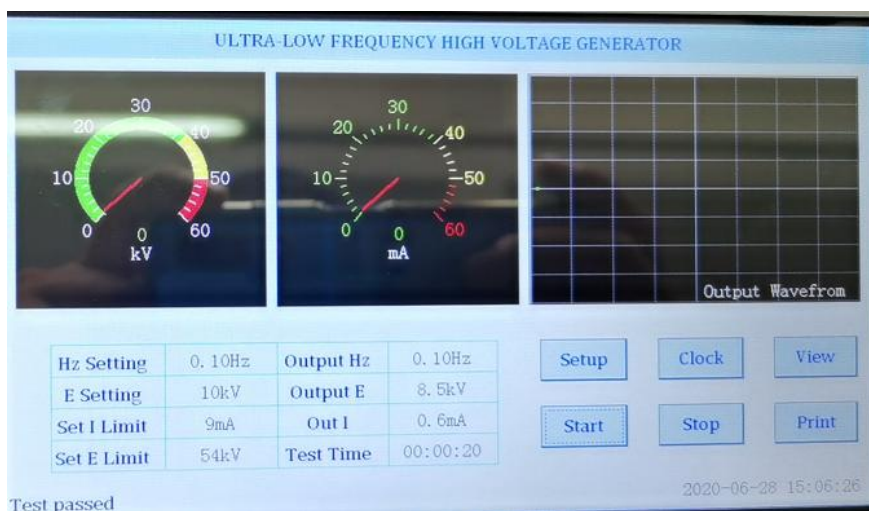

Figure 9 controller prompts to stop the test

The instrument stops the high-voltage output and automatically discharges the test object, as shown in Figure 10. The prompt message in the status bar is "discharging".

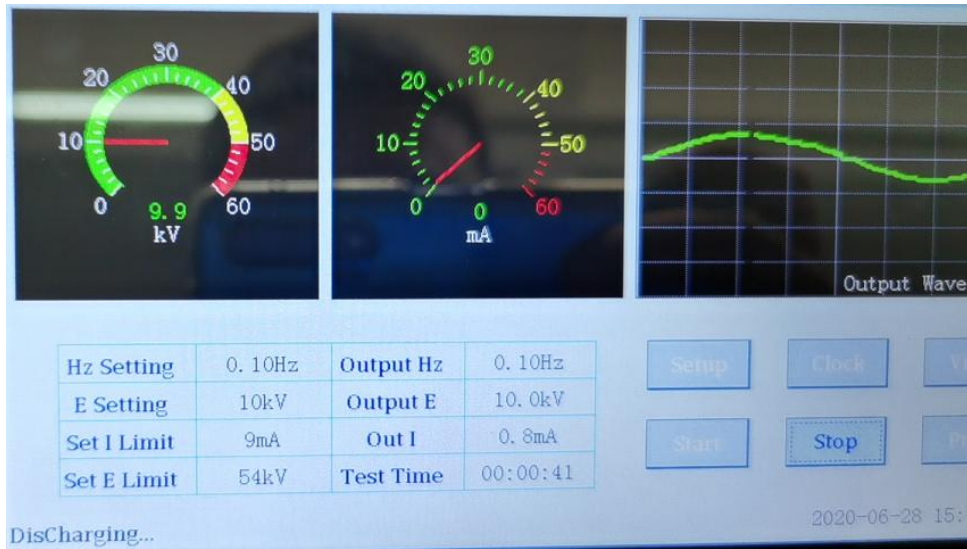

Figure 10 the controller indicates that it is discharging

After the shutdown, as shown in Figure 11, the prompt message in the status bar is "test passed" and the data history is saved.

Note: during the test, if there is no abnormal voltage, no discharge or overcurrent protection, the test can be considered as passed.

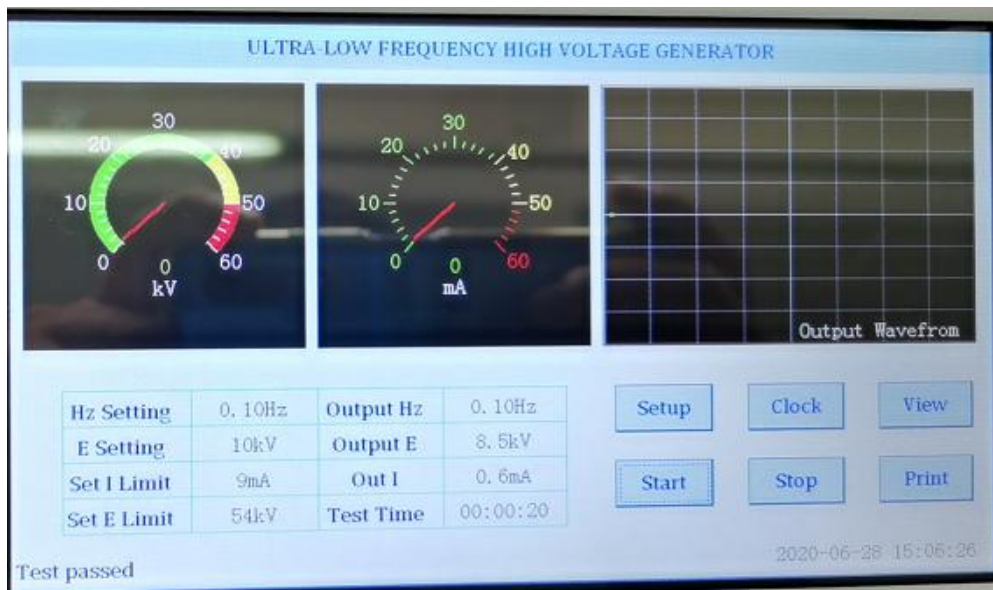

Figure 11 controller prompt test passed

This instrument provides two shutdown modes:

- ★ timed shutdown: when the timing reaches the set time, the instrument will stop automatically.
- ★ manual shutdown: click the "shutdown" key to stop the machine. The two shutdown modes are normal shutdown.
- ★ there are also two kinds of abnormal shutdown: over-voltage protection shutdown and over-current protection shutdown.
- ★ overvoltage protection shutdown

In the process of test, when the output high pressure exceeds the set limit, the instrument will automatically cut off the output after starting and shutting down the command, and then execute the data history saving. After shutting down, as shown in Figure 12, the prompt message in the status bar is "over voltage protection" and execute the data history saving.

Fig. 12 controller prompts over voltage protection

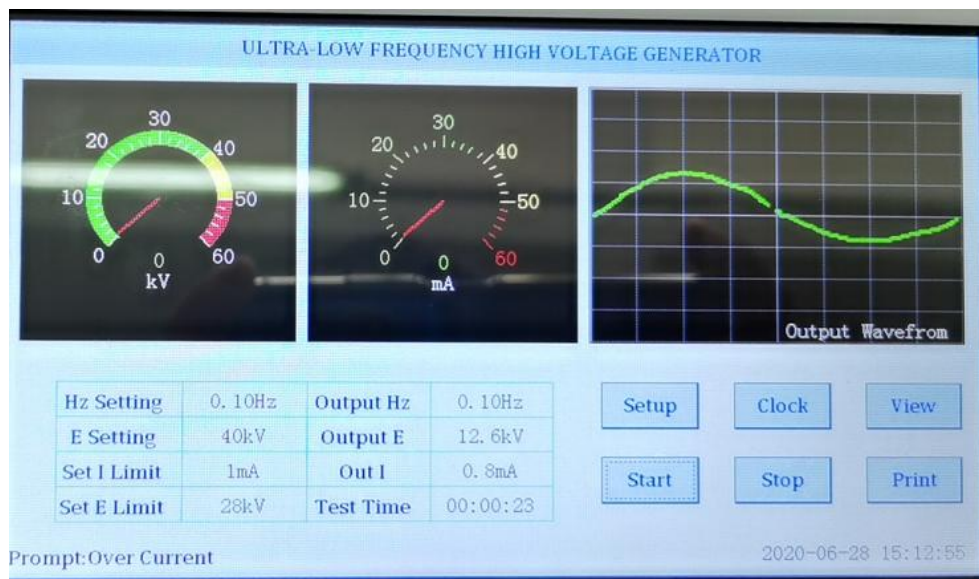

- ★over current protection shutdown

In the process of test, when the output current exceeds the set limit, the instrument will automatically cut off the output after starting and stopping the command, and then

execute the data history saving. After the shutdown, as shown in Figure 13, the prompt message in the status bar: "overcurrent protection" and execute the data history saving.

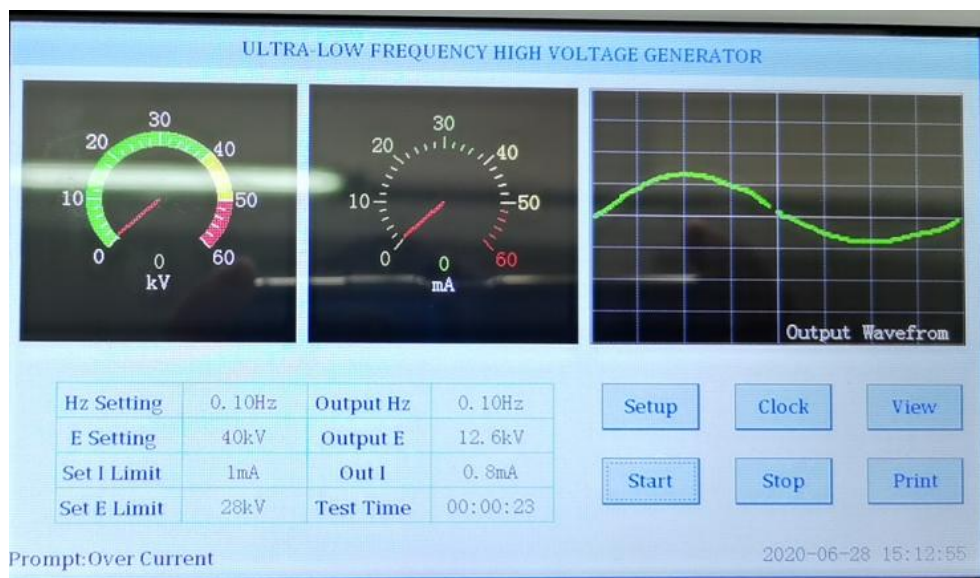

Fig. 13 over current protection prompted by controller

(4) printing

Click the "print" key in Figure 3 to print the data on the display into a test report. Under the status of viewing historical data, click the "print" key to print the historical data currently displayed on the screen.

(5) view historical data

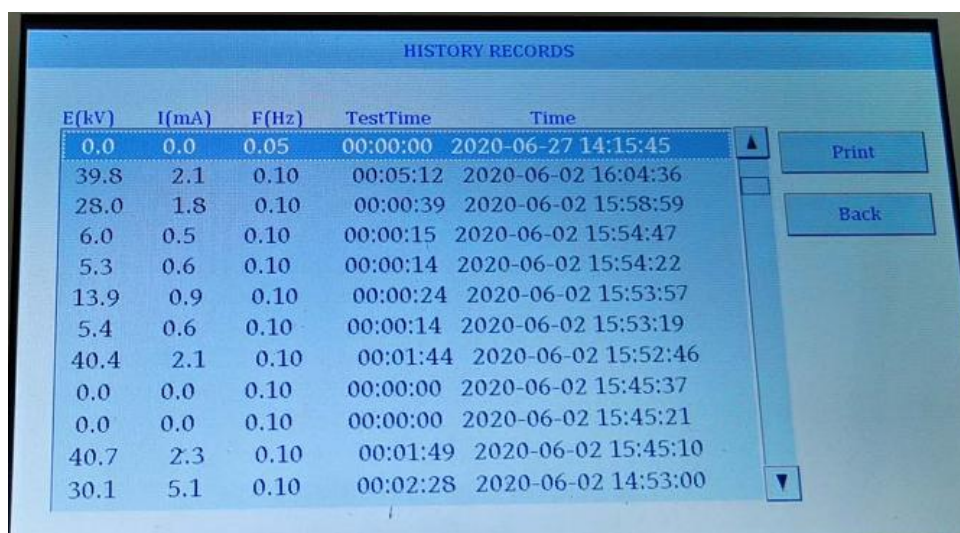

Figure 14 historical data interface

All the data instruments that have been shut down by timing, clicking the "stop" key, over-voltage protection and over-current protection will automatically save them as historical data. It can save

up to 64 times of measured data, and the previous 64 times will be deleted automatically. Click the "view" key in Figure 3 to open the interface in Figure 13 to view the historical data of the latest 64 tests.

(6) Clocksetting

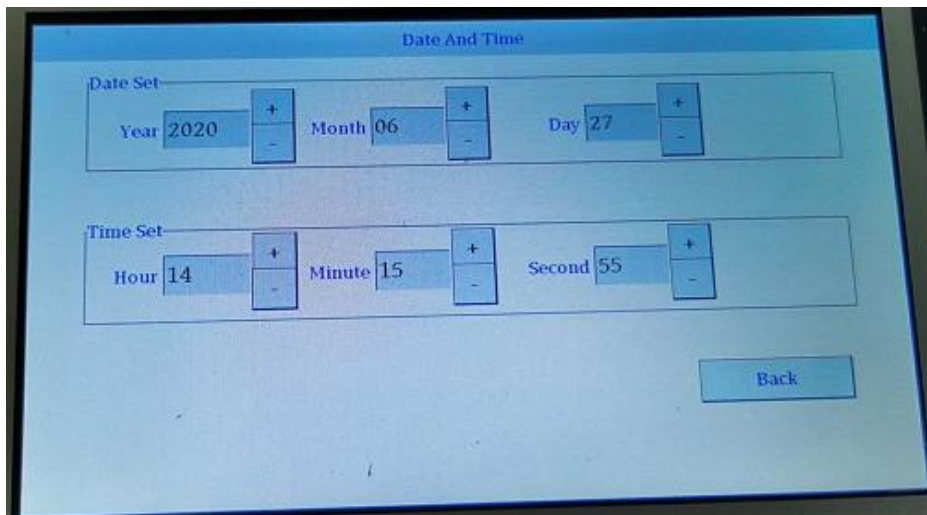

Figure 15 date and time setting interface

Click the "clock" button in Figure 3 to open the setting interface in Figure 15, which is used to set the date and time of the system.

**3. Upper computer background management software**



This instrument is equipped with VLF super low frequency and high voltage generator upper computer background management software, as shown in Figure 15. The software supports Windows XP \ 2000 \ 2007 and other operating systems. The software can be installed on the computer and connected with the USB of the controller through the USB connection line. All the operation functions of the controller can be operated on the software, such as setting parameters, starting the boosting test, saving historical data, etc.

## VII. Power Cable Withstand Voltage Test Method

1. Disconnect all electrical equipment connected to the tested cable.
2. Use a megger to test the insulation parameters of each phase of the cable, and carry out the ultra-low frequency withstand voltage test only after the test is qualified.
3. Set the test voltage value:  $U_{max} = 3u_0$ , where  $u_0$  is the rated phase voltage of the cable.  
 Example 1: cable parameter: the rated line voltage is 10kV, and the rated phase voltage  $u_0 = 6kV$ , so the test voltage setting value is:

$$U_{max} = 3u_0 = 18kV$$

See Table 4 for the setting value of 0.1Hz ultra-low frequency test voltage of various rubber and plastic insulated power cables.

Table 4 0.1Hz ultra-low frequency test voltage and time of various rubber plastic insulated power cables.

Rated voltage $U_0/U_s(kV)$	Handover test		Preventive experiment			
	multiple	Test voltage (kV)	Test time (mins)	multiple	Test voltage (kV)	Test time (mins)
1.8/3	$3U_0$	5	60	$3U_0$	5	15
3.6/6	$3U_0$	11	60	$3U_0$	11	15
6/6	$3U_0$	18	60	$3U_0$	18	15
6/10	$3U_0$	18	60	$3U_0$	18	15
8.7/10	$3U_0$	26	60	$3U_0$	26	15
12/20	$3U_0$	36	60	$3U_0$	36	15
21/35	$3U_0$	63	60	$3U_0$	63	15
26/35	$3U_0$	78	60	$3U_0$	78	15

Note:  $U_N$  is the rated voltage of the cable, and  $u_0$  is the phase voltage of the cable.

4. Test time: 60 minutes for handover test and 15 minutes for preventive test.

5. Setting current value of overcurrent protection:

Estimation method of capacitive current (or leakage current) of ultra-low frequency withstand voltage test article:

$$I_0 = 2\pi f C U = 2 \times 3.14 \times 0.1 C U (mA) \dots \dots \dots (formula 1)$$

C is the electric capacity of the cable to the ground, unit: UF; u is the effective value of the test

voltage, unit: kV.

Example 2: a 10KV (UN = 10kV, uo = 8.7kv) cable is 4km long, with a single phase to ground capacitance of 0.21uf/km and 0.1Hz super

If the low frequency test voltage is 26kv (peak value), the leakage current is approximately:

$$I_0 = 2 \pi fCU = 2 \times 3.14 \times 0.1 \times 0.21 \times 4 \times 26 / \sqrt{2} = 9.69 \text{ (mA)}$$

Setting current value of overcurrent protection: I=kIo

..... (formula 2)

## VIII. Transportation And Preservation

### (1) transportation

The product must be packed during transportation. Cartons can be packed in cartons or wooden boxes, and foam proof layer should be placed in the packing box. The packed products shall be able to be transported by road, railway and air. It shall not be placed in the open truck during transportation. The warehouse shall be protected from rain, dust and mechanical damage.

### (2) storage

When the instrument is not used at ordinary times, it should be stored in a room with ambient humidity of - 20 °C ~ + 60 °C, relative humidity of no more than 85%, ventilation and no corrosive gas. Storage should not be close to the floor and walls.

### (3) moisture proof

In humid areas or wet seasons, if the instrument is not used for a long time, it is required to turn on and power on once a month (about two hours) to make the moisture emission and protect the components.

### (4) anti exposure

When the instrument is used outdoors, direct sunlight exposure shall be avoided or reduced as much as possible. When the instrument is used outdoors, direct sunlight exposure shall be avoided or reduced as much as possible.

## IX. Quality Assurance

(1) the instrument is manufactured in strict accordance with national standards and enterprise standards, and each instrument is subject to strict factory inspection.

(2) the instrument enjoys a one-year warranty period, the company will provide free warranty within warranty time and offer life-long after-sales service.

(3) within the service life of the instrument, the company will provide the maintenance, use training, software upgrade and other related services of the instrument for life.

(4) if you find any problems in use, please contact our company in time, and we will solve the problems asap.

## X. Paper Change Method Of Printer

The operation of replacing the paper roll of the printer is very simple. It does not need to take out the whole printer. Just press the open button to open the front cover. Open the front cover as shown in Figure A and take out the remaining paper core. Then install the new paper roll as shown in Figure B and close the front cover as shown in Figure C.

Note: when closing the front cover, make the printing paper stretch out from the paper outlet, put it in the middle position, and let the rubber shaft fully press the printing paper, otherwise it can't be printed. When the thermal printer is loading paper, it must be confirmed that the thermal coating of the thermal paper is on it, and then put the thermal paper into the printer paper bin. If the thermal coating is not on

the correct side, no writing will be printed. If the printing paper deviates, you can open the front cover again and adjust the position of the printing paper.

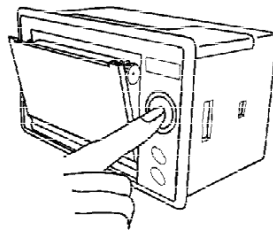

A How to open the front cover

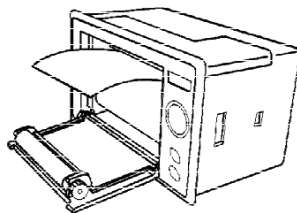

B Printer in roll

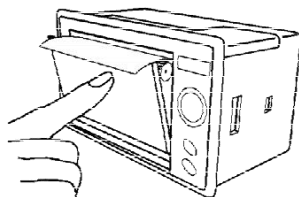

C Close the front cover of the printer

## **XI. Common Faults**

1. 80kV withstand voltage equipment maximum output is only 78kV, how to solve?

A: Please use stable mains voltage for the test. The voltage booster with load has a large voltage capacity and requires a large power (W). Please replace the stable power supply and test again.

2. The voltage boost of the ultra-low frequency withstand voltage does not reach the rated voltage, and there is an abnormal prompt. What is the problem?

Answer: Limit test, abnormal grounding, resulting in our instrument can not large load voltage, only down frequency 0.05Hz. When the ground is reliable, 0.1HZ can do 1.5 km cable, the whole ungrounded test, affecting the load capacity of the instrument.

3. Our waveform output is particularly irregular, why is it not a regular dark wave shape?

Answer: Please connect the control box, booster and test (cable ground) to the same ground potential. Cable shield grounding needs to be connected in series

4. Ultra-low frequency equipment works for 90 minutes, the booster is particularly hot, and does not work, do not boost, start the test protection. Answer: ultra-low frequency working limit is 60 minutes, static 15 minutes after the completion of the pressure test, the machine is particularly hot must wait for cool down, open the air valve to vent again test.

5. Can the output voltage of our generator set be 240V, the frequency is 60Hz, and the power is 7000W?

Answer: ultra-low frequency power 220V frequency: 50Hz/60Hz general, power: control box power 20W, booster power, boost process can reach 2000W, configuration of power inverter, ordinary generator and other power supply, the use of plug and row power to  $\geq 3000W$

## **XII. Packing List**

<b>No.</b>	<b>Name</b>	<b>Qty</b>
1	Controller	1
2	Booster	1
3	HV Cable	1
4	LV Cable	1
5	Power Cable	1
6	Discharge Rod	1
7	Grounding Wire	1
8	Fuse	4
9	Print Paper	2